

Paramount

SARA FIREPLACE









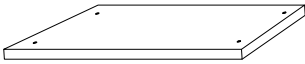

WOOD MANTEL ASSEMBLY INSTRUCTIONS

model no. GM1

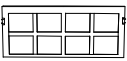

For customer service, parts or warranty issues:
Call 1-800-561-5550
or e-mail parts@jrhome.com

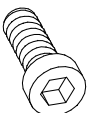
****DZ3 insert must be used with the Sara Mantel****

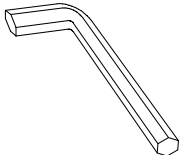
WOOD MANTEL INCLUDES				
 MIDDLE SHELF PANEL	 TOP PANEL	 BACK PANEL	 RIGHT SIDE PANEL	 LEFT SIDE PANEL
 GLASS DOOR	 FRONT CENTER PANEL	 BASE PANEL		
HARDWARE INCLUDED				
 WASHER=14+1	 ALLEN SCREW=14+1	 BACK PANEL SCREW=8+1	 ALLEN WRENCH=1	

* Save this manual for future reference.

ASSEMBLY INSTRUCTIONS

WARNING: Do not move insert while operating
* Save this manual for future reference.

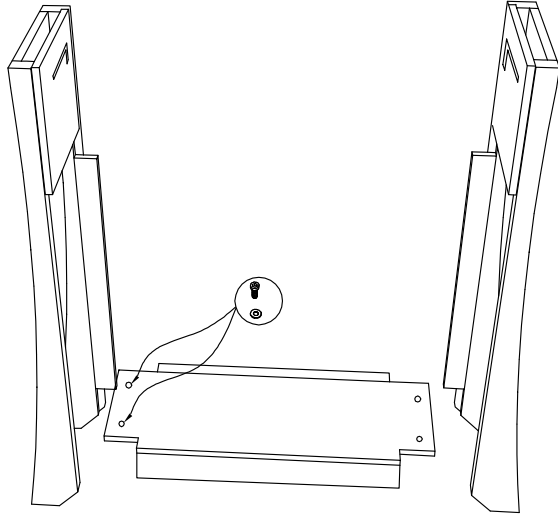

STEP 1

1. Connect right side panel with base panel by securing 2 allen screws and 2 washers, repeat the same procedure for left side panel with base.

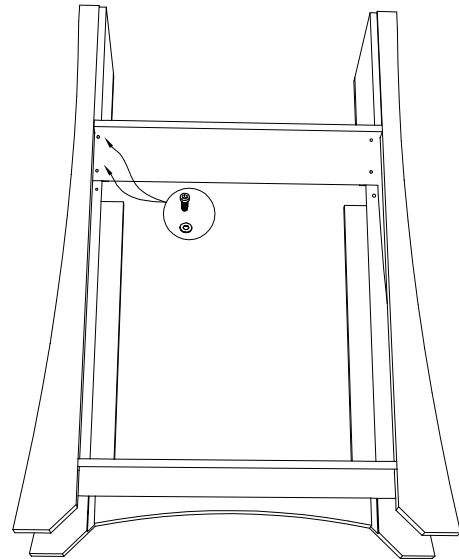

STEP 2

2. Connect middle shelf panel with right side panel by securing 2 allen screws and 2 washers, repeat the same procedure for the left side panel with middle shelf panel.

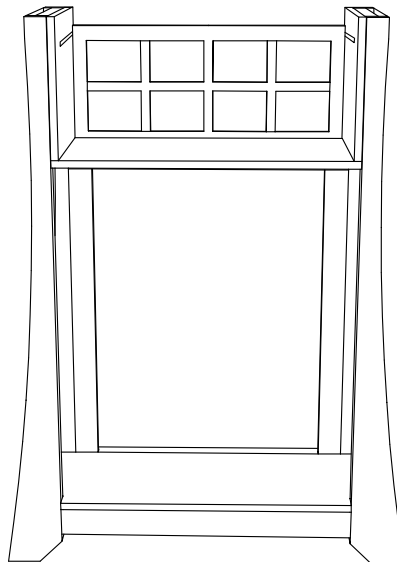

STEP 3

3. Insert the shelf pin on glass door into the guide on two side panel.

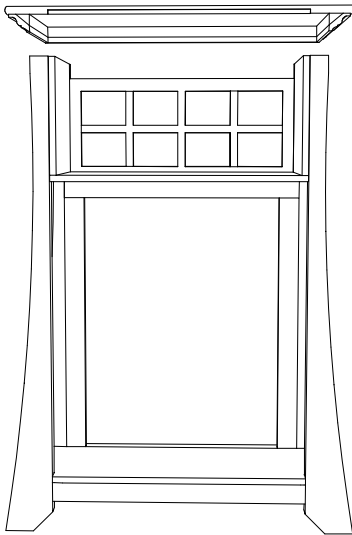

STEP 4

4. Connect the front center panel to left and right side panel by securing 2 allen screws and 2 washers.

STEP 5

5. Use allen wrench to strengthen all hardware

STEP 6

6. located the top on above finished step. Join it with two side panels by securing 4 long allen screws and 4 washers.

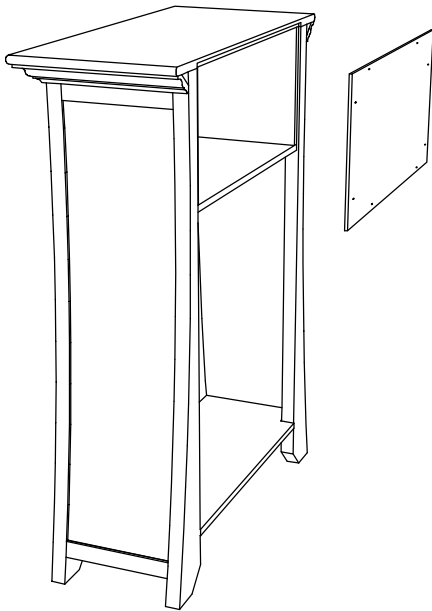

STEP 7

7. Attach the back panel to top and side panel by securing 8 pcs small screws.

Positioning against the wall

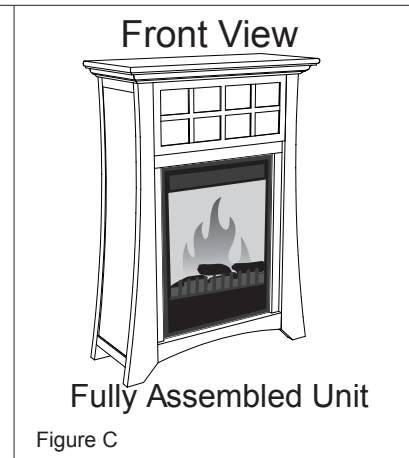
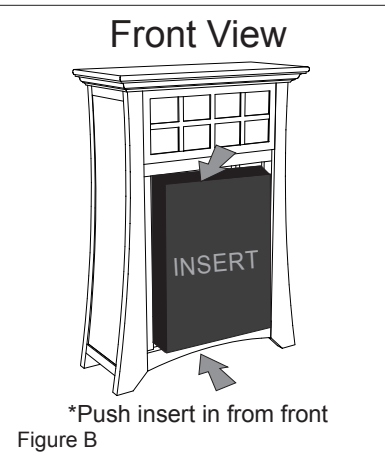
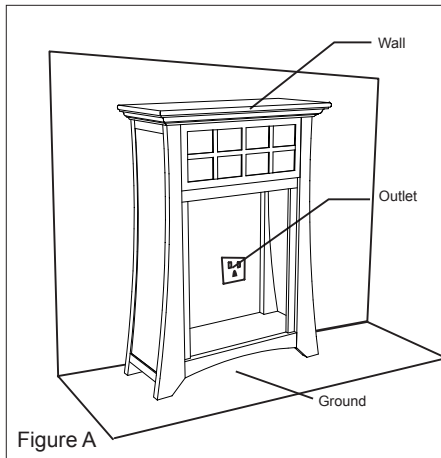

IMPORTANT

**Do not return this product to the store. Please call
our customer service department for any questions
or concerns:**

**Monday to Friday
7:00AM to 5:00PM P.S.T.**

**DATED PROOF OF PURCHASE REQUIRED FOR
WARRANTY SERVICE.**

1-800-561-5550

If you have any questions or concerns regarding the
warranty or service please e-mail: parts@jrhome.com
1-800-561-5550